

**AN INNOVATIVE INTEGRATED APPROACH
TO WHOLE LIFE COSTING**

Mohammed Kishk*, Assem Al-Hajj and Robert Pollock

The Scott Sutherland School

The Robert Gordon University

Garthdee Road

Aberdeen AB10 7QB.

* Corresponding Author

E-mail: m.kishk@rgu.ac.uk

Tel: 01224 263710

Fax: 01224 263777

- A number of recently developed algorithms are combined to build an innovative integrated whole life costing approach.
- The integration process is based on the simple idea of breaking the decision-making process into a logical series of activities. Then, the appropriate algorithms are employed to model each activity and link it with other activities.
- The most unique feature of the approach is that various levels of information availability and different types of uncertainty of information are dealt with effectively by the most appropriate algorithm(s).
- Besides, critical stages of the decision-making process are automated and various scenarios of the decision making process are logically handled by a carefully designed decision algorithm.
- Furthermore, the approach is computationally effective because all repeated calculations are eliminated and the optimum level of the recycle process is automatically identified.

Keywords: Decision-making, Integration, Life cycle costing, Whole life costing.

INTRODUCTION

In the last two decades, several researchers and practitioners have suggested practical models for implementing whole life costing (WLC) as a decision making tool. In general, these approaches can be broadly classified into two main categories. In the first category, the implementation is carried out sequentially in a number of predefined steps (e.g. Smith, 1983 and Ferry and Flanagan, 1991). These steps usually include the following main activities

- Preparation.
- Data analysis
- WLC calculations.

- Evaluation of non-financial attributes using the weighted evaluation (WE) technique.
- Evaluation results for results and risk.
- Decision-making.

In the second category, a logical order is also followed and a recycle procedure is adopted to generate new alternatives or refine existing alternatives if the decision is inconclusive (e.g. Kirk and Dell'Isola, 1995). The latter implementation approach is in line with design as an iterative process towards the ultimate objective of identifying the ideal design alternative.

One limitation of existing implementation models is that the choice of the most appropriate WLC model, i.e. a net present value (NPV) model or an equivalent annual cost (EAC) model, is left to the analyst. This choice may be problematic especially for non-technical users.

Another limitation of almost all implementation models is that no systematic method exists for making the decision especially when the results are subject to uncertainty.

However, there is still a need to systematise and automate it to minimise the number of iterations required to achieve a conclusive decision.

In a series of papers (Kishk and Al-Hajj, 2000a, 2000b, 2000c, 2000d), the authors employed the fuzzy set theory (FST) to develop three models and algorithms to handle subjective assessments of input parameters in whole life costing (WLC). In a subsequent paper (Kishk and Al-Hajj, 2001a), another algorithm has been developed to handle stochastic data and

expert assessments as represented by probability density functions (PDFs) and fuzzy numbers (FNs), respectively, within the same model calculation.

Recently, a WLC-based decision support algorithm has also been developed (Kishk and Al-Hajj, 2001b). This algorithm systematically analyses uncertain input data and provides the decision-maker with a better impression of their validity and usability by the employment of two sets of measures. The first set includes two confidence measures to evaluate the rank ordering of various competing alternatives. The second set includes two uncertainty measures to identify the significance of various costs regarding the ambiguity of the decision. More recently, another algorithm has been outlined to include non-financial attributes of competing alternatives into the decision-making process (Kishk et al., 2001). These algorithms are based on an integrated theoretical framework for WLC outlined in an earlier paper (Kishk and Al-Hajj, 1999). This framework was proposed on the basis of an in-depth analysis of various difficulties facing the implementation of WLC in the industry.

The objective of the research work that underpins this paper was to integrate these algorithms into a well-defined approach to achieve more computational efficiency by eliminating repeated operations and to automate critical stages of the decision-making process. In the next section, the logic of the integration process is introduced. Then, the detailed design of the integrated approach is reported using simple process flow diagrams. For convenience of the reader, basic symbols used in these diagrams are summarised in an appendix.

LOGIC OF INTEGRATION

In general, all existing implementation models involve the following main stages:

- Preparation.
- Data analysis
- WLC calculations.
- Evaluation of non-financial attributes using the weighted evaluation (WE) technique.
- Ranking of competing alternatives.
- Decision-making.
- A recycle process if the decision is inconclusive.
- Output.

In the preparation stage, alternatives are generated and their data are assessed such that the uncertainty of each data item is properly represented. Thus, crisp values, FNs, PDFs are employed to model certain, subjectively assessed, and statistically significant data items, respectively. Then, other stages are followed to decide upon the optimum alternative. Obviously, these activities flow in the above sequence if both financial and non-financial attributes of alternatives are considered. However, there are two other scenarios to consider in the design of the integration logic flow. The first scenario is that only WLC calculations need to be considered. In this case, the WE step should be skipped. The second scenario is that no WLC calculations are required and only a WE is needed. This situation usually occurs during early stages of the design process when there is usually no detailed cost information. In this case, the WE is used primarily as a screening device prior to a detailed WLC exercise (e.g. example 8.2). Based on these arguments, a flow diagram of the integration process can be constructed as shown in Fig. (1).

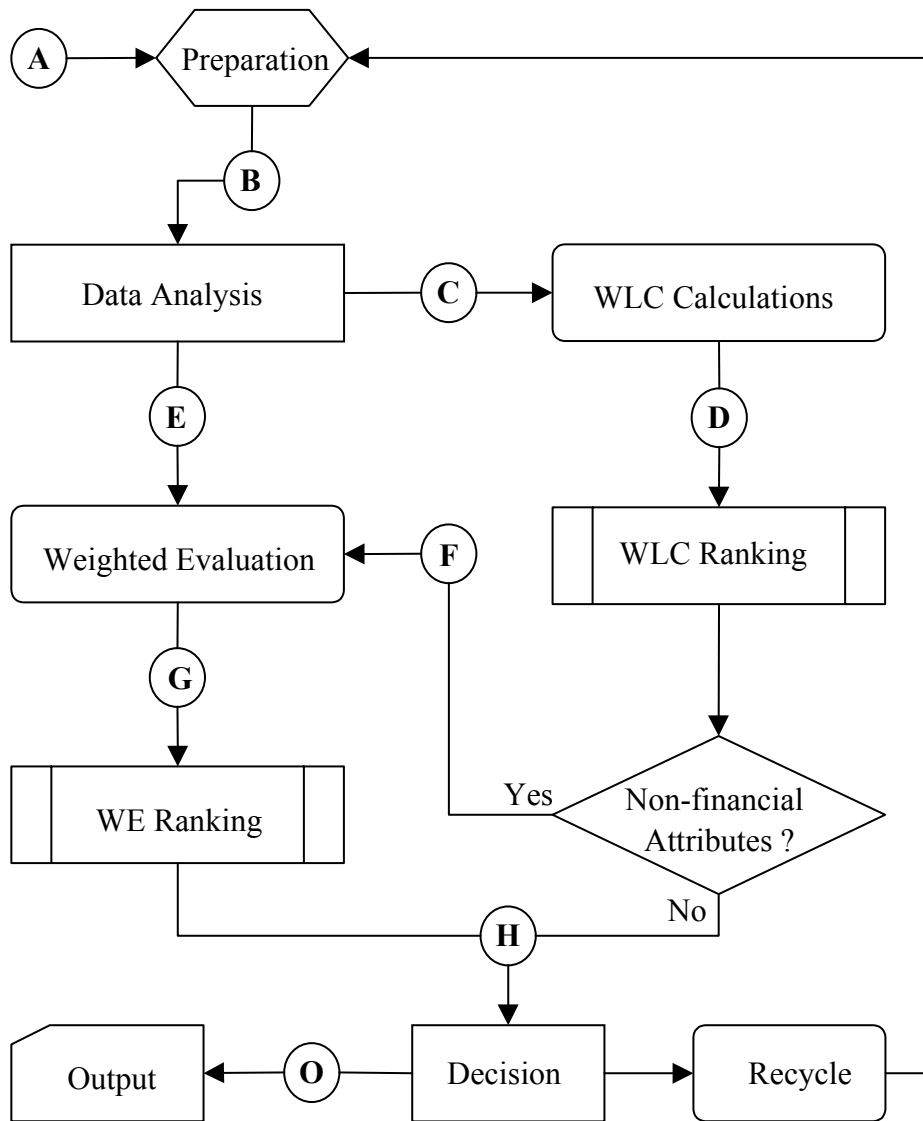

Fig. (1): The integration process flow diagram.

DETAILED DESIGN OF THE INTEGRATED APPROACH

In this section, various algorithms are integrated to fit in the process flow diagram outlined in figure (1).

Data Analysis

Two basic requirements for an effective integration of various algorithms can be identified. The first requirement is that all data items are represented by fuzzy numbers. Thus, all data items represented by PDFs should be manipulated by the transformation algorithm (Kishk and

Al-Hajj, 2001a) to obtain equivalent FNs. In this way, all data items are represented by FNs. The second requirement is that the appropriate method(s) are identified to deal with the nature of information at hand. If only intangible data are available, only a weighted evaluation can be conducted. On the other hand, a whole life costing analysis should be carried out first if detailed cost information is available. Figure (2) shows a simplified flow chart of this process.

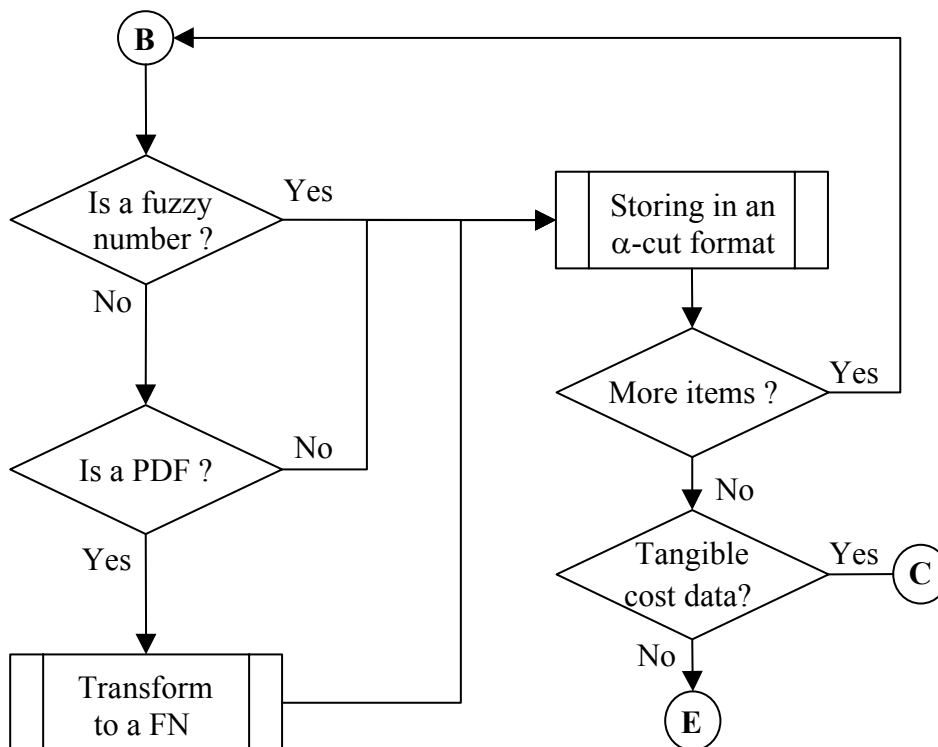

Fig. (2): α -cuts representation of data.

3.2 WLC Calculations

Another basic requirement is that the most appropriate WLC model is employed to deal with the problem under consideration. The NPV model (Kishk and Al-Hajj, 2000b) is used when an analysis period is specified by the decision-maker; while the EAC model (Kishk and Al-Hajj, 2000d) is more appropriate when the lives of alternatives are different. When only normalised data are available, either the normalised NPV model (Kishk and Al-Hajj, 2000c)

or an equivalent normalised EAC model is used. This automatic procedure of identification of the appropriate model has clear advantage for non-technical users of the approach. Figure (3) shows a simplified flow chart of how the most appropriate model can be automatically identified.

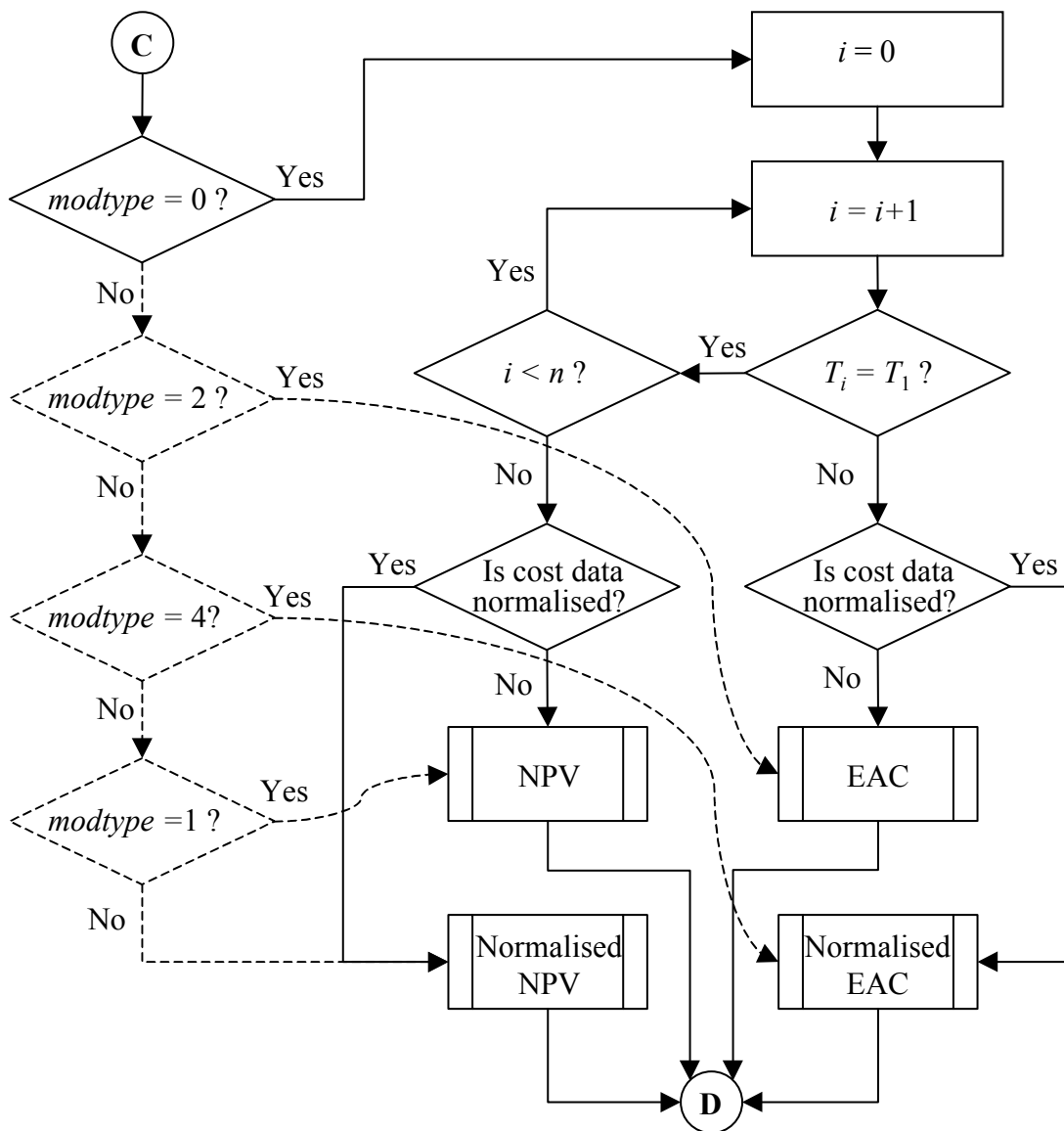

Fig. (3): The automatic identification of the most appropriate WLC model.

In addition to this automatic procedure, a manual procedure is included to allow technical decision-makers to have control over the choice of the model being used if he/she is interested in knowing the WLCs of alternatives in a specified format, e.g. as equivalent annual costs

(EACs). The logic flow in this case is depicted with dotted lines. As shown in Fig. (3), the automatic procedure is activated if the *modtype* variable is set to 0. On the other hand, if the *modtype* variable is set to 1, 3, 2 or 4, the NPV, normalised NPV, EAC, or normalised EAC, is activated, respectively.

After identification of the appropriate algorithm, the corresponding WLC measure is calculated to link the WLC calculation activity with the WE and ranking activities. On the other hand, uncertainty measures of the WLC contribution of each cost are calculated within the selected algorithm to be used as an indication to what extent the initial uncertainty of that cost is still present in the final evaluation. In this way, the tie-breaking algorithm (Kishk and Al-Hajj, 2001b) can be employed to link WLC calculations with both the ranking and preparation activities as shown later.

Non-Financial Attributes

Obviously, the integrated approach should also be able to consider all financial and non-financial criteria specified by the decision-maker in determining the most optimum alternative. This requirement entails that the most appropriate overall ranking criterion is identified automatically depending on the case at hand. Three situations can be identified (Kishk, 2001).

- At early stages of the design process or when screening all possible alternatives prior to a WLC exercise, the total score (Ferry and Flanagan, 1991), is the only possible criterion because no detailed cost information is available.
- When the relative importance of costs and non-financial criteria to the decision-maker should be considered, the use of the total combined score (Kishk, 2001) is crucial. However, the use of the benefit to cost ratio (BTC), is recommended in the case of uncertainty-tied alternatives.

- When the relative importance of costs and non-financial criteria are not necessary, the BTC ratio is the only possible criterion.

Figure (4) shows a simplified process flow diagram of how the most appropriate criterion can be automatically identified.

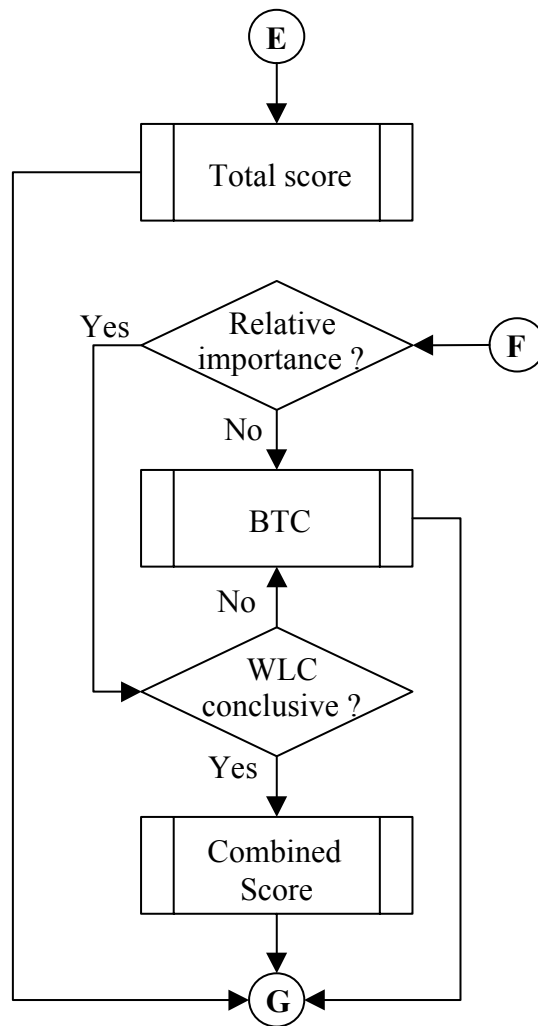

Fig. (4): Automatic identification of the most appropriate evaluation method.

Decision Making

The final activity before making the decision is to rank various competing alternatives. According to the confidence measures in this ranking, the following six scenarios are possible.

- The most desirable scenario is that a single alternative has a clear advantage over all other alternatives. In this case, the results of the analysis are conclusive and no further iterations are required. The example application given in Kishk and Al-Hajj (2000b) is a sample of this scenario.
- In a second scenario, two or more alternatives outrank all other alternatives with acceptable confidence measures. In this case, these alternatives are tied and the decision is partially conclusive. A possible means of breaking this tie is to identify data items that contribute significantly to the ambiguity of the decision. Then, a recycle process is carried out to refine these data items. Of course, only tied alternatives are considered in the recycle process and all other alternatives are eliminated. Obviously, the cost of the WLC exercise can be significantly reduced by considering significantly uncertain items only in the recycle process. The example application given in Kishk and Al-Hajj (2001b) is a sample of this scenario.
- The third possible scenario is that all remaining alternatives are tied. In this case, significantly uncertain items can be identified and a recycle process is carried out as done in the second scenario but considering all alternatives. However, some or all alternatives may still be tied after the recycle process. In this case, all data items may need refinement for a possible enhancement of the decision.
- The fourth possible scenario is that all remaining alternatives are still tied and no further refinement of data is possible. In this case, it is possible to achieve a conclusive decision by including other criteria in the decision-making process. For example, non-financial attributes may have a decisive role to play for WLC-tied alternatives.
- The fifth possible scenario is that all remaining alternatives are still tied and no further refinement of data and criteria is possible. The only remaining means to achieve a conclusive decision is by development of other alternatives or refinement of existing

alternatives. Obviously, this scenario requires the highest level of effort to complete a WLC exercise because almost all preparation activities have to be repeated.

- The last and most unfavourable scenario is that all remaining alternatives are still tied and no further development of alternatives is possible because of the limitations of the time and resources available and/or the constraints of the project specifications and performance standards. In this case, the whole WLC exercise may be considered null and void and the final selection of the ideal alternative should be based on optimising an economic criterion other than WLC such as initial costs or energy costs, or simply left to the decision-maker.

A thorough analysis of the above scenarios reveals that there are four recycle levels depending on the number of scenarios required to achieve a conclusive decision. These levels, arranged according to the effort required, are summarised in Table (1).

Table (1): Recycle levels required to achieve a conclusive decision.

Recycle level	Required activities
1	<ul style="list-style-type: none"> • Revise significant data items.
2	<ul style="list-style-type: none"> • Revise all data items.
3	<ul style="list-style-type: none"> • Revise all data items. • Modify decision criteria
4	<ul style="list-style-type: none"> • Revise all data items. • Modify decision criteria • Generate and/or refine existing alternatives.

As shown, the set of activities in each level is a subset of the activities in the next level and consequently the amount of effort required increases proportionally with the recycle level. Besides, four activities can be identified: generating alternatives, identifying decision criteria,

compiling data and revising significant data items. Figure (5) shows a simplified process flow diagram of the decision process. As shown, the four identified activities of the preparation stage are arranged in a logical order and linked properly with various decision scenarios.

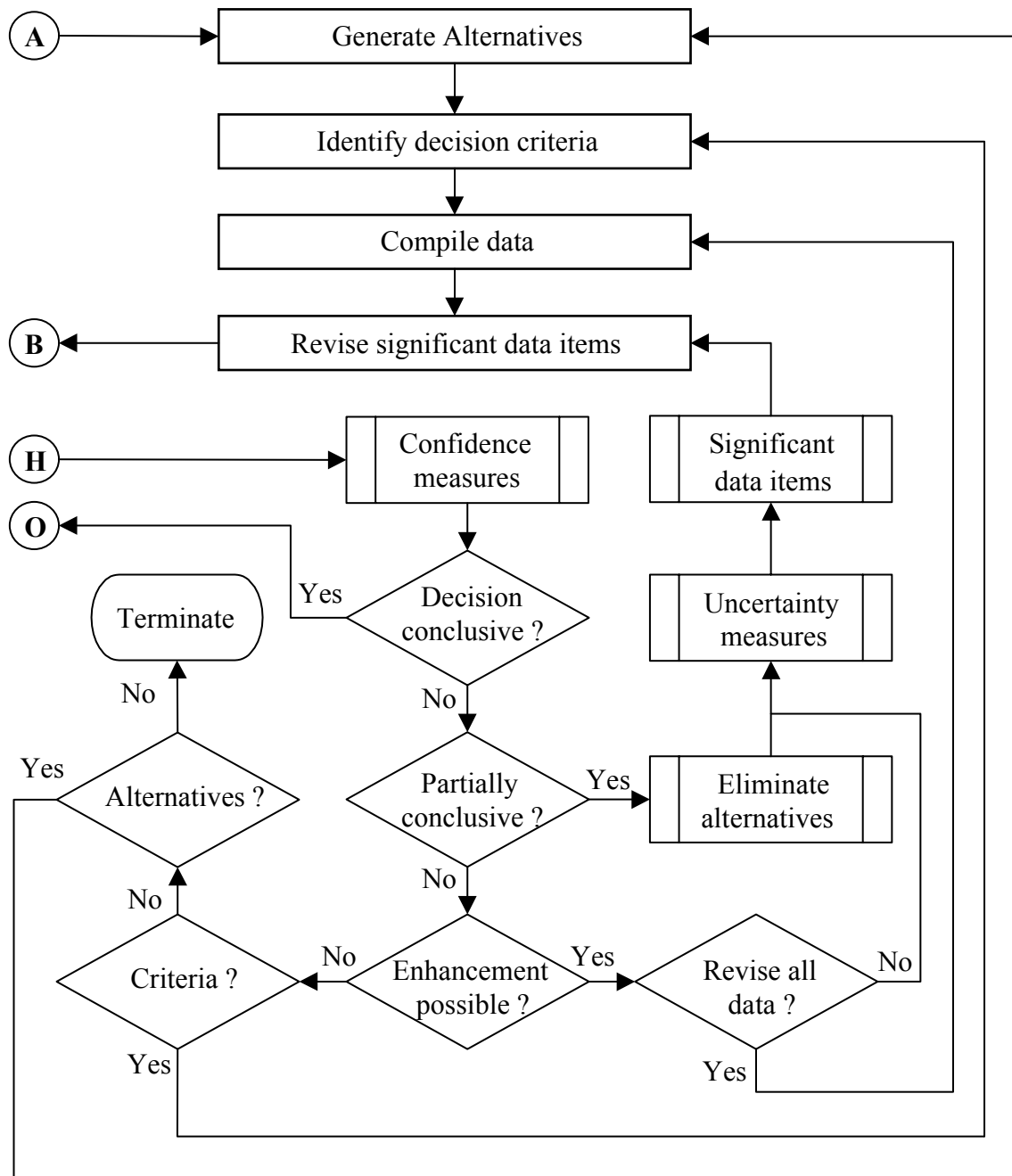

Fig. (5): Process flow diagram of decision-making.

The Complete Process Flow Diagram

To outline the process flow diagram of the integrated approach, figures (2 to 5) are simply joined according to the integration framework outlined in Fig. (1). This complete process flow diagram is shown in Fig. (6).

CONCLUSIONS

A number of recently developed WLC algorithms have been employed to build an integrated WLC approach. The decision-making process has been broken down into a logical series of activities. Then, the appropriate algorithm(s) are employed to model each activity and link it with other activities. This has been done such that various scenarios of the decision making process are logically handled by a carefully designed decision algorithm. In addition, critical stages of the decision-making process are automated. Furthermore, various levels of information availability and various facets of uncertainty are dealt with effectively by the most appropriate algorithm(s). It is believed that this innovative approach is the first comprehensive WLC-based decision-making methodology to appear in the literature.

It is anticipated that by making the analysis process more objective, straightforward, and less expensive, the WLC technique can receive extensive practical application in the industry. This research produced a seminal work that makes an important contribution towards the realisation of this objective.

ACKNOWLEDGEMENTS

The authors would like to thank the anonymous referees of the paper for their useful comments and suggestions.

REFERENCES

- Ferry, D. and Flanagan, R. (1991) *Life Cycle Costing - A Radical Approach*, CIRIA Report 122, London.
- Kishk M. and Al-Hajj A. (1999) An integrated framework for life cycle costing in building. *Proceedings of the RICS construction and building research conference (COBRA'99)*, The University of Salford, September 1-2, 1999, 2, 92-101.

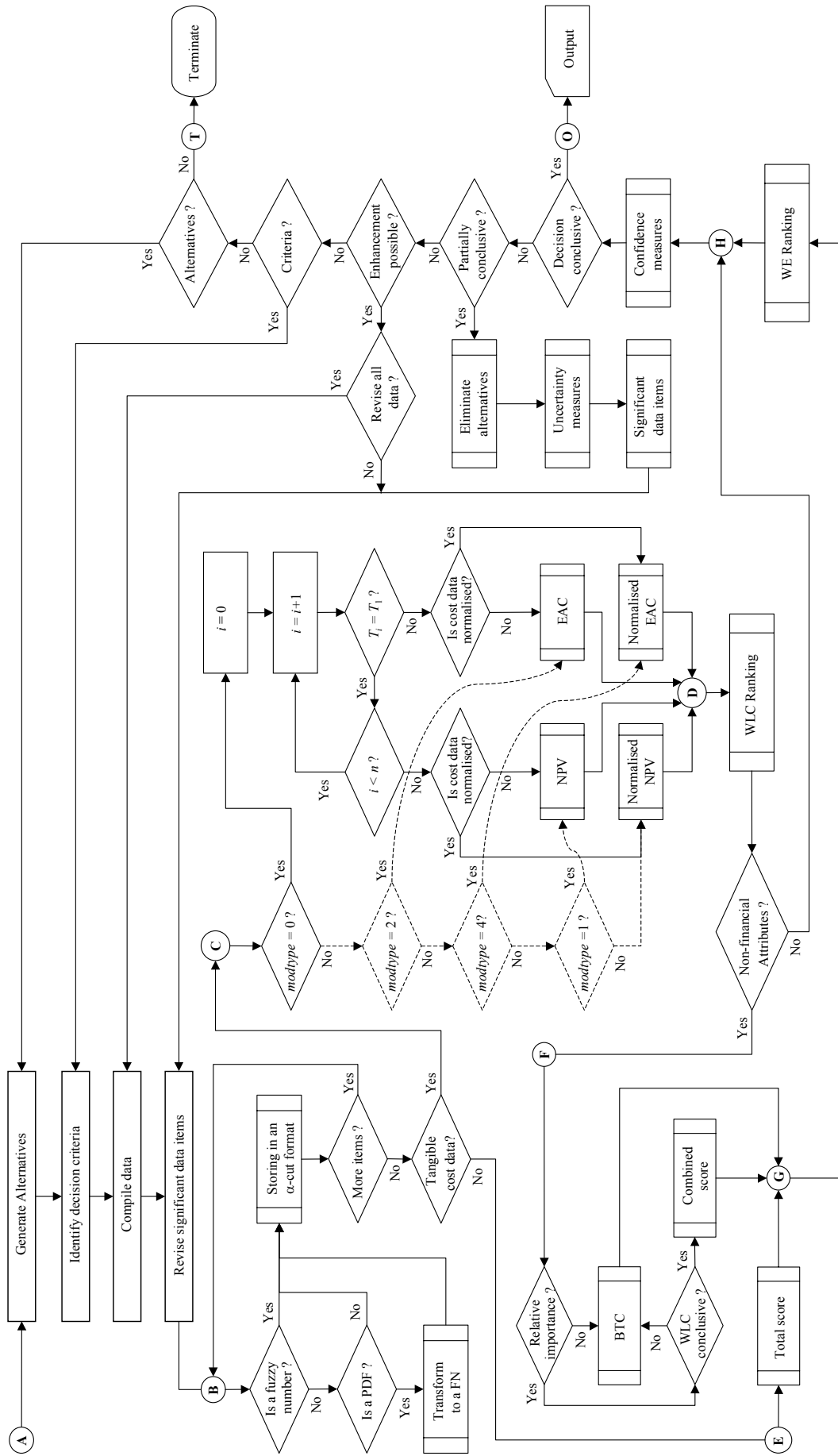



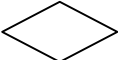

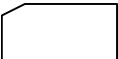



Figure (6): The process flow diagram of the integrated approach.

- Kishk M. and Al-Hajj A. (2000a) A fuzzy approach to model subjectivity in life cycle costing. *Proceedings of the BF2000 national conference of postgraduate research in the built and human environment*, The University of Salford, 9-10 March, 270-280.
- Kishk M. and Al-Hajj A. (2000b) A fuzzy model and algorithm to handle subjectivity in life cycle costing based decision-making. *Journal of financial management of property and construction*, 5 (1-2), 93-104.
- Kishk M. and Al-Hajj A. (2000c) Handling linguistic assessments in life cycle costing - a fuzzy approach. *Proceedings of the construction and building research conference of the RICS research foundation (COBRA2000)*, The University of Greenwich, 30 August - 1 September, 2000, 228-243.
- Kishk M. and Al-Hajj A. (2000d) Modelling of life cycle costs of alternatives with different lives. *Proceedings of the 16th annual conference of the Association of Researchers in Construction Management (ARCOM'2000)*, Glasgow Caledonian University, 6-8 September, 577-586.
- Kishk M. and Al-Hajj A. (2001a) Integrating subjective and stochastic data in life cycle costing calculations. *Accepted for publication in the first international postgraduate research conference in the Built and Human Environment*, University of Salford, 15-16 March, 10-21.
- Kishk, M.; and Al-Hajj, A. (2001b) An innovative approach to integrating the analysis of uncertainty into life cycle costing. *Proceedings of the first international conference of Innovation in Architecture, Engineering and Construction*, Loughborough University, 19-20 July, 411-421.
- Kishk, M., Al-Hajj, A. and Pollock, R. (2001) Inclusion of non-financial factors in life-cycle decision-making - a fuzzy approach. *Proceedings of the 17th Annual Conference of the Association of Researchers in Construction Management*, University of Salford, 5-7 September, 2001, 1, 411-420.
- Kishk, M. (2001) An Integrated fuzzy approach to whole life costing based decision making. *Unpublished PhD Thesis*. The Scott Sutherland School, Robert Gordon University, Aberdeen.
- Kirk, S., J. and Dell'Isola, A. J. (1995) *Life cycle costing for design professionals*. McGraw-Hill Book Company, New York.
- Smith, J. (1983) Life Cycle Costing. *The Building Economist*, Dec, 321-323.

APPENDIX: LIST OF SYMBOLS

	Process.
	Alternate process.
	Predefined process.
	Decision.
	Preparation.
	Output.
	Terminator.
	Connector.

Although these algorithms tackle almost all the difficulties associated with WLC modelling, they need to be integrated